

**Spänl**

[www.spanl.nl](http://www.spanl.nl)

# Metal Siding

**MORE**

Lasting Beauty  
Light Weight  
Fast Installation  
Waterproof

## Easy Products B.V

Bedrijfsweg 2A, 6627 BC, Maasbommel  
E-mail: [sales@spanl.nl](mailto:sales@spanl.nl)

Product specifications are subject to change without prior notice. All the test data which tested by Spanl Lab(China) is just for reference. For printing reason it may cause color difference in this brochure. All products will be based on the actual products received. Please contact our sales people for detailed information before you do a purchase.

**Spänl**

# 9 ADVANTAGES



Sound Insulation



3D Pattern

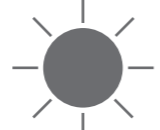

Thermal Insulation



Waterproof



Light



Fast Installation



Eco-friendly



Durable



Self-cleaning

## JUST FOR GOOD LIVING



Spanl metal siding is designed for beauty and durability. We are becoming the home exterior siding of choice for top builders.

Spanl metal siding meets the demand of our clients and the level of the building that they are producing.

10 years professional color coating experience creates ultimate lifelike texture.

We spare no efforts to develop high-end decorative metal siding.

15 years guarantee for the fading of color coating.

Self-cleaning technology makes your house cleaner.

Say hello to a low maintenance exterior wall.



# Spanl

# PRODUCT INTRODUCTION

## 3 key components of SPANL METAL SIDING

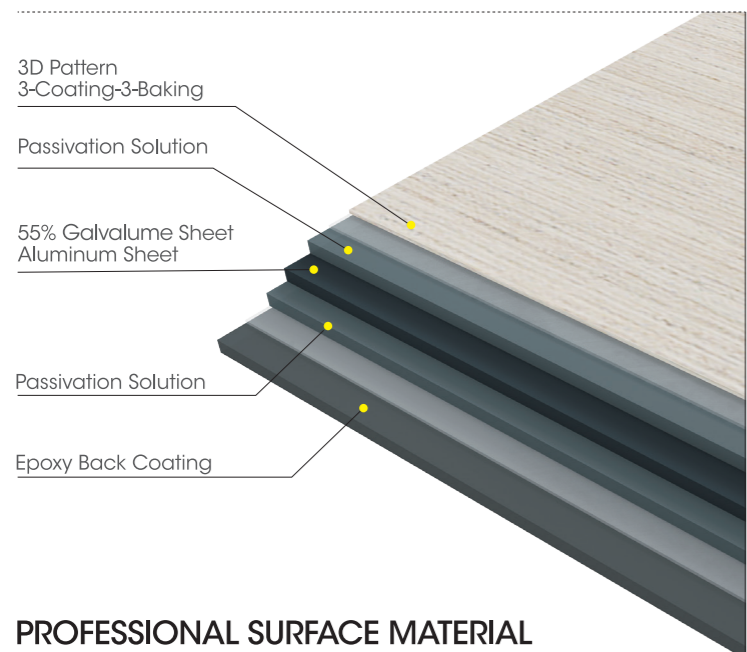
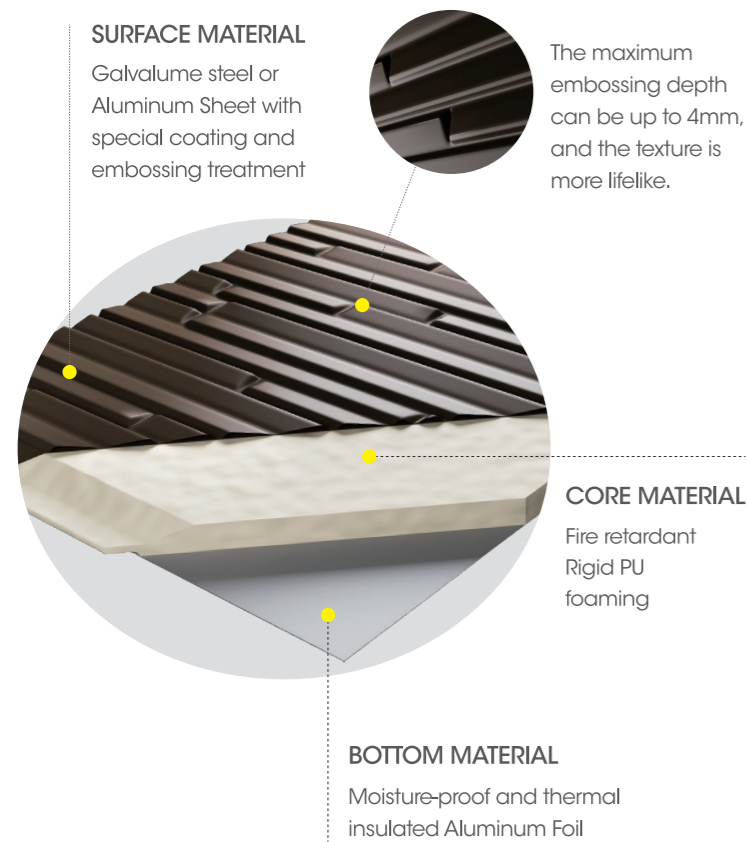

SPANL METAL SIDING takes the advantages of enough metallic touches as well as the ultimate visual experience to make the wall is no longer monotonous. Various color choices with highly visual texture enables SPANL METAL SIDING to be used both in the field of building interior decoration and exterior decoration, meeting the personalized decorative needs of users.

### THREE WIDTH OPTIONS

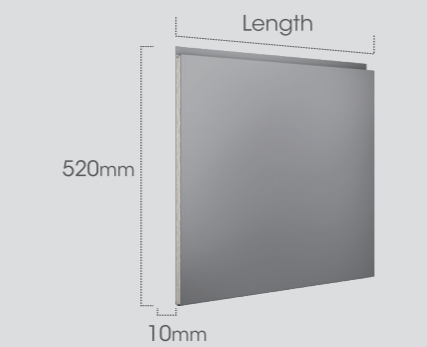
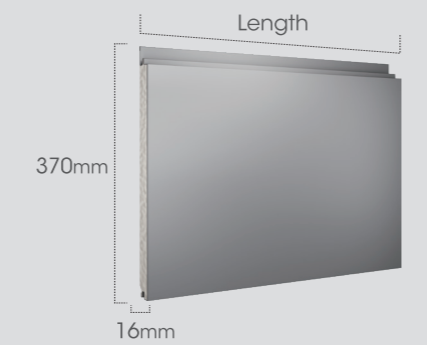
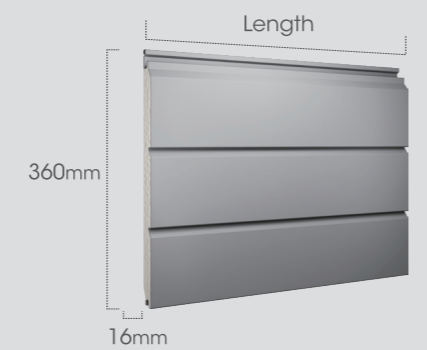

LENGTH: 3800mm/5800mm/Customized

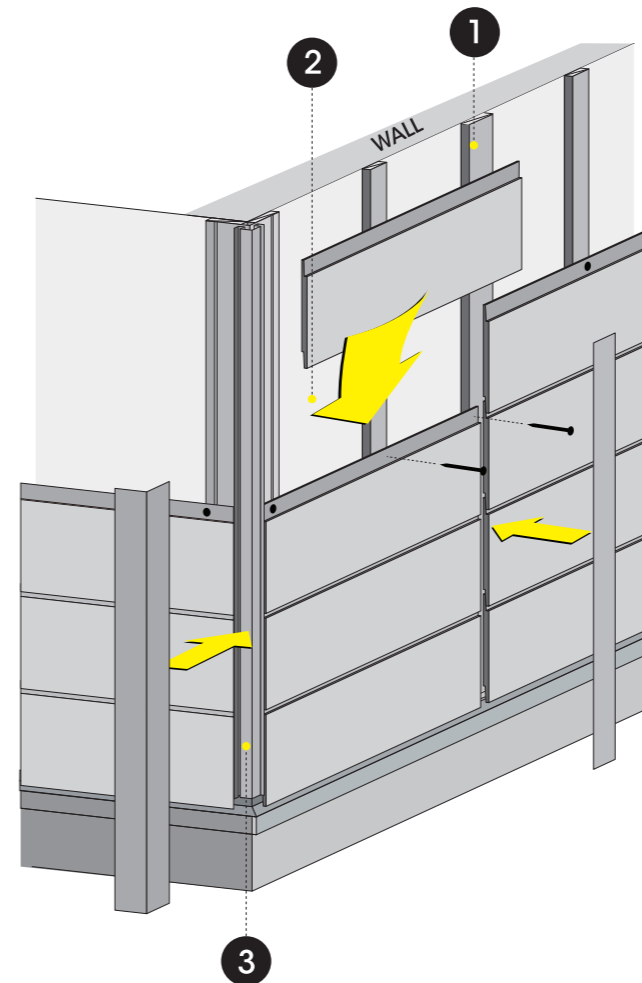

1

Install frame on the wall and then starting parts at the bottom.

Frame should be steel or antiseptic wood frame

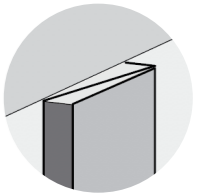

2

Install the panel with self-tapping screws.

Spacing shall be less than 50cm

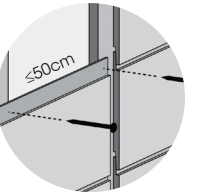

3

All the accessories should be filled with weathering adhesive before and after installation.

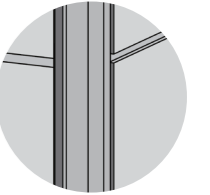

### PRODUCT PERFORMANCE

Item	Test Result	Test Standards
Density (PU)	45 kg/m <sup>3</sup>	GB/T6343-2009
Compression Strength (PU)	320.4 kpa	GB/T8813-2008
Thermal Conductivity (PU)	Average Temp.: 10°C	GB/T10295-2008
	Average Temp.: 25°C	
Water Absorption (PU)	0.8%	GB/T8810-2005
Horizontal Burning (Core Material)	HF-1	GB/T8332-2008
Combustion Performance	B	GB/T20284-2006
Heat Transfer Coefficiency	1.50W (m <sup>2</sup> ·K)	GB/T13475-2008
Sound Reduction Index	25dB	GB/T19889.3-2005 GB/T50121-2005
Fluorescent Uv Arc Aging (Steel Sheet)	OK	GB/T16422.3-2014

The above data is tested by National Building Material Test Center. For more details please contact Spanl headquarter(china).

**2019**  
NEW

# COMING SOON



## SPANL METAL SIDING

**17 STYLES , 150+ CHOICES**

Provide Abundant Options With Ultimate Visual Impact  
2019, We spare no efforts to have more new designs for our customers.

## Professional metal siding, ONLY Spänl

Coating with 18 processes, under 300 °C high temperature baking.

AkzoNobel painting, more color selections and realistic visual effects, better quality assurance.



### REVOLUTIONARY COATING

SPANL METAL SIDING adopts the high-performance coating by AkzoNobel can be easily suitable for different climate and provide superior solutions for coating fading, loss of glossiness, UV erosion.

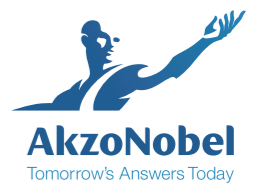

### DURABILITY

The traditional coating lacks the ability in maintain the glossiness, Spanl' s coating use micron pigments, whose molecular structure is more compact, makes UV deterioration resistance more stronger.



### TRADITIONAL COATING

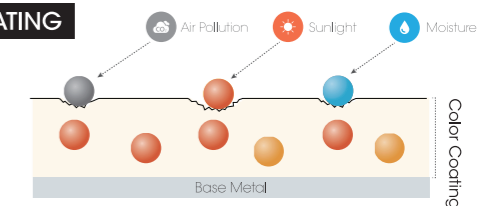

### SPANL COATING

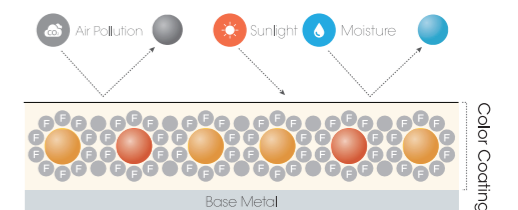

### SELF-CLEANING

#### TRADITIONAL WALL

Self-cleaning technology has polar group molecules, good hydrophilicity, and form thin molecular membranes when combined with water. After dust attachment, it is easy to fall off after rainwater scouring.

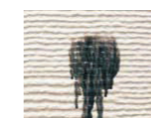

Stained



Easy to be stained, hard to be flushed

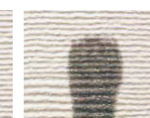

Wall stained and can not be cleaned by rainwater

#### SPANL SIDING

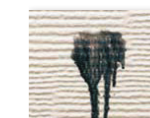

Stained

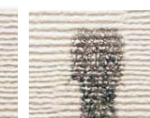

Hard to be stained, easy to be flushed

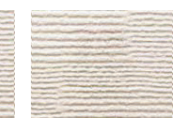

Easily cleaned by rainwater and fresh as new

The anti-ultraviolet and anti-pollution ability, due to the different environment, the actual effect will also vary.



## BREATHING WALL

### AIR-CIRCULATION METHOD

With this method, the rainwater on the backside of the panel can be discharged quickly, preventing moisture condensation and sunlight heat into the room.

- 01**  
Anti-condensation
- 02**  
Discharge inside rainwater
- 03**  
Increase air conditioner efficiency
- 04**  
Slowing down house aging



### WATERPROOF

As shown in the picture, SPANL METAL SIDING can provide perfect waterproofness. According to the recommendation of installation, the water tightness can reach more than 550pa.

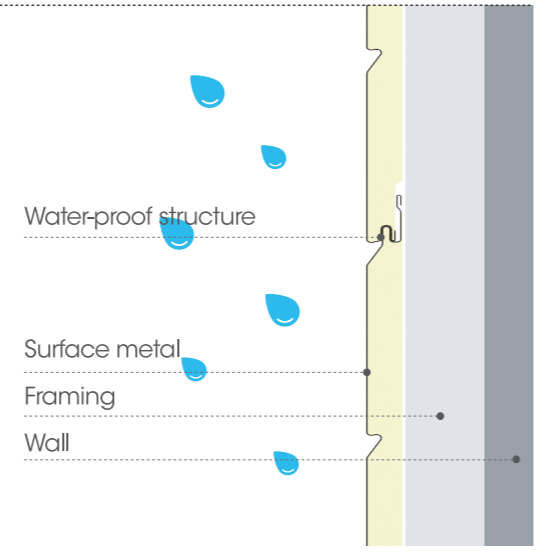
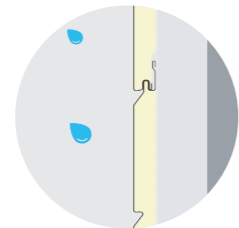

### CONSTRUCTION

Comparing with fiber cement with the same thickness, SPANL METAL SIDING is lighter and faster and safer installation.

	Spanl Metal Siding	Fiber Cement
Material	Metal	Cement
Width	370mm	455mm
Thickness	16mm	16mm
Weight	3.5kg/m <sup>2</sup>	14kg/m <sup>2</sup>

### FROST RESISTANCE

In extremely cold region, traditional external wall materials are easily to be crack and damaged due to thermal expansion and cold contraction. SPANL METAL SIDING is made of metal with enough strength and filled with PU foaming, with low water absorption and good resilience. In extreme weather, the combination of the two materials ensures a good appearance of wallboard and extender its lifetime.

### SOUND INSULATION

SPANL METAL SIDING has an excellent sound insulation effect. As shown in the picture, in the case of 1000Hz, SPANL METAL SIDING can reduce around 40dB, creating a quiet home for you.

- \* FRAME:
- Spanl Siding: 16mm
- Profile Frame: 18mm
- Wall: 105mm
- Gypsumboard: 9mm

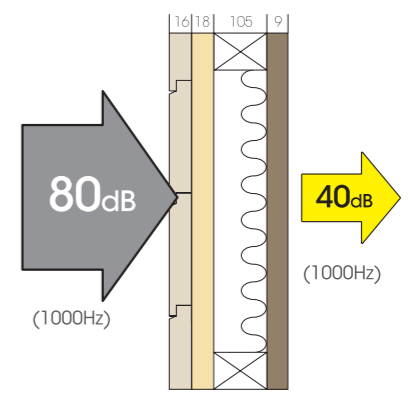

### THERMAL INSULATION

The PU foaming used in SPANL METAL SIDING has low thermal conductivity, and its unique closed-porosity and high resistance to gas diffusion make its thermal insulation performance last longer enough. In the same thermal insulation requirements, SPANL METAL SIDING can reduce the building envelope thickness to increase the use of indoor area.

#### Thermal Conductivity

Spanl Metal Siding	0.03 (0.02)
Fiber Cement	0.17

# Spänl

## EXTERIOR WALL DECORATION

Beautiful and elegant



## PROJECTS

### Application scene

SPANL METAL SIDING can be used for exterior decoration, remodeling, ceiling, background wall decoration, interior wall decoration, etc.



## CEILING DECORATION

Unique style



## BACKGROUND DECORATION

Urban and stylish



## INTERIOR WALL DECORATION

Classic designer style

## REMODELING

Getting a new look.



# 6 SERVICES



1

### PROFESSIONAL COIL COATING

10-year-experience  
 South-Korea Printing Equipment  
 German Siemens Electronic Control Equipment  
 Coating with 18 processes, under 300 °C high temperature baking

2

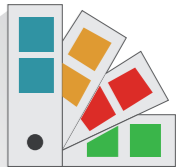

### LEADING PRINTECH

Datacolor Chromometer Detection  
 MG Deviation Correction System For Accurate Alignment

### 3 3D PATTERNS

Numerous Three-dimensional Models  
 More Visual Impact  
 Advanced R&D Team  
 Professional R&D Technology

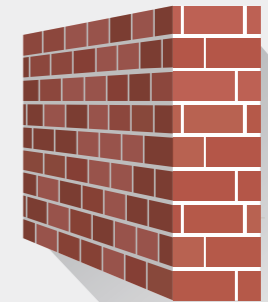

### 4 PURSUIT OF DETAILS

Professional Formulation Polyurethane  
 High Quality Aluminum Foil  
 Integrated Molding



5

QUALITY TESTING- REST ASSURED BECAUSE OF SPECIALTY



High And Low Temperature Test  
 Salt Spray Test  
 Detection Of Oxygen Index  
 Peel Test

6



AFTER-SALES GUARANTEE MAKE YOU WORRY-FREE